

1 Safety Notice

- 1.1 Please read the manual carefully before using the projector.
- 1.2 To ensure a stable power supply, please use a national standard power cable and power cord with grounding.
- 1.3 Please use the right power cord for the projector, as an improper power cord may cause damage to the projector.
- 1.4 Do not disassemble the machine yourself; otherwise, the company will not undertake warranty service.
- 1.5 Avoid looking directly at the projector lens while the machine is working, as it might cause damage to your eyes.
- 1.6 To prevent the projector vents from clogging, do not cover them with cloth, carpet, or other materials.
- 1.7 This projector does not have waterproof functionality; please keep it away from rain, moisture, and other liquid containers, such as vases or cups.
- 1.8 To prevent electric shock, please keep the projector away from rain, water, or moisture.
- 1.9 If you do not plan to use this projector for a long period, please cut off the power supply.
- 1.10 When transporting the projector, use the original foam or other shock-absorbing materials to protect it.
- 1.11 If you encounter problems with the projector, please contact the brand; do not attempt to repair it yourself.
- 1.12 To extend the projector's lifespan and protect your eyesight, we recommend taking a break after using it for 3-4 hours.

2 Interface Introduction

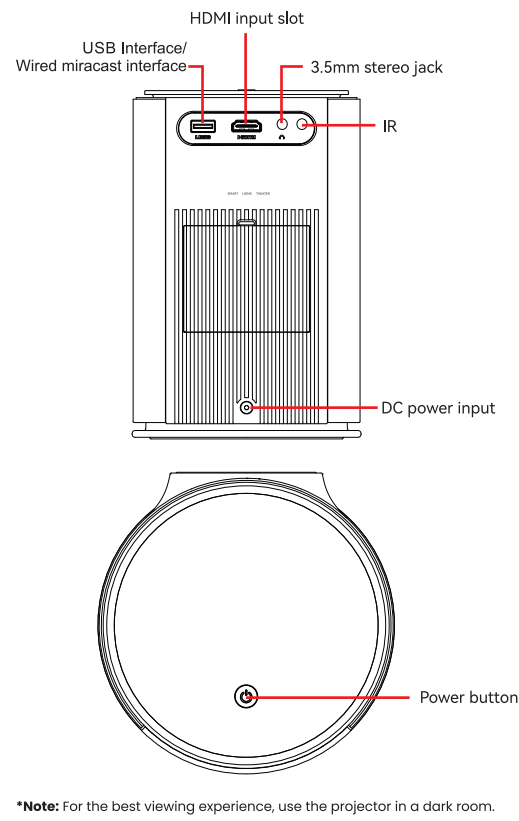

3 Remote Control Introduction

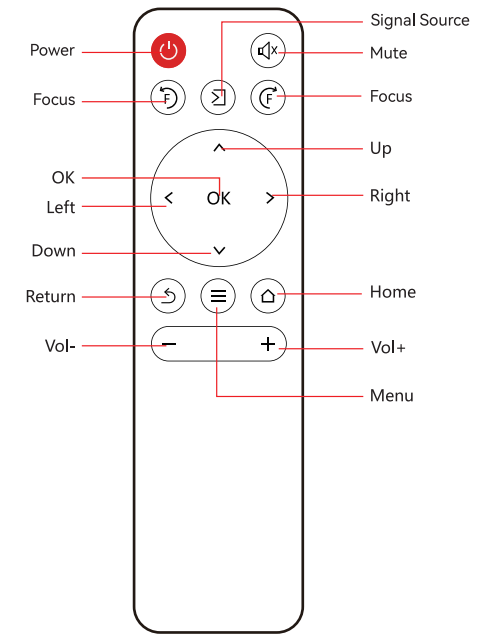

- *NOTE:**
- 3.1 To avoid power shortages, please do not mix old and new batteries.
 - 3.2 To prevent battery leakage and corrosion, remove the battery if the remote control will not be used for an extended period.
 - 3.3 When using the remote control, align the remote control's signal transmitter with the projector's infrared signal reception window.
 - 3.4 For optimal usage, please use the remote control from the backside of the projector.

4 Media Connectivity

4.1 USB Connection

Connect a USB flash drive with the desired content to the projector's USB port. Then, navigate to the "Media" section where you can select items such as movies, music, photos, and text from the list.

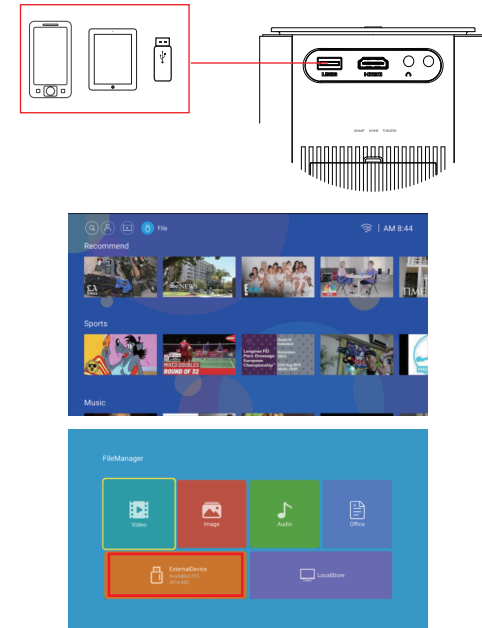

4.2 HDMI connection

The HDMI interface allows you to connect the projector to computers and other devices equipped with an HDMI output interface. Once connected, select the appropriate HDMI channel.

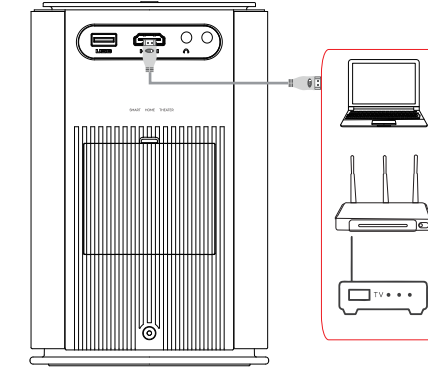

HDMI

The terms HDMI and HDMI High-Definition Multimedia Interface, and the HDMI Logo are trademarks or registered trademarks of HDMI Licensing Administrator, Inc. in the United States and other countries.

4.3 3.5mm AUX Connection

Connect a 3.5mm earphone or speaker equipment to the projector for audio output.

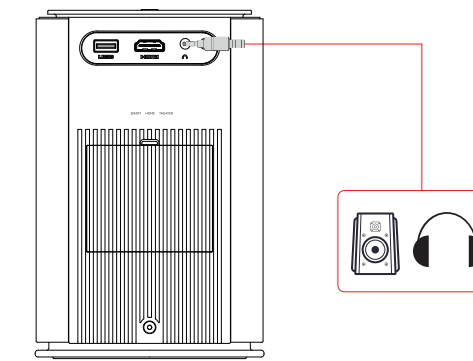

5 Keystone Correction

You can use the Keystone Correction function to adjust the uneven-shaped image to make it evenly rectangular. This helps you fix the image when the projector is not in front of the middle of the screen.

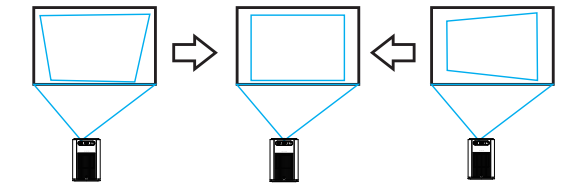

- Here's how to perform Keystone Correction, via the remote-
- Step 1: Go to Settings
 - Step 2: Settings > Projector Settings > Keystone Advanced > 4-Point Keystone
 - Step 3: Press the Left/Right arrow buttons for Horizontal Keystone Correction, and the Up/Down arrow buttons for Vertical Keystone Correction

6 Search Page

This page allows you to search for a wide range of content for viewing purposes.

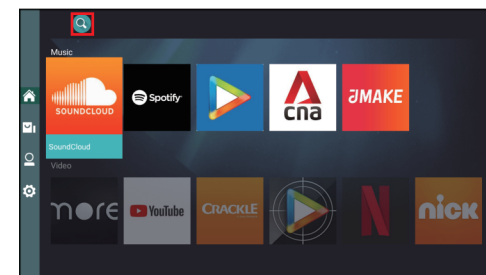
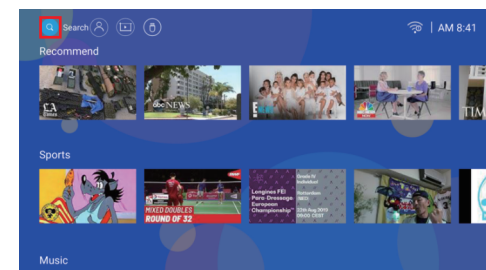

7 Setting up Menu

To begin, open the homepage and select "Settings." Within the settings menu, you can make adjustments to various options, including WiFi, Bluetooth, Image Projection, Language, Date, Applications, System Updates, and more.

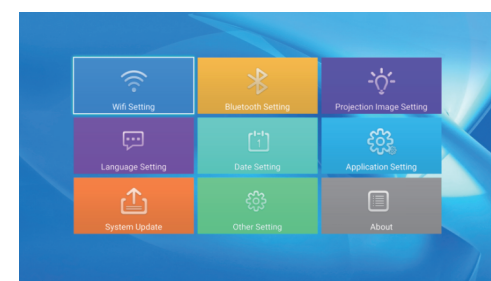
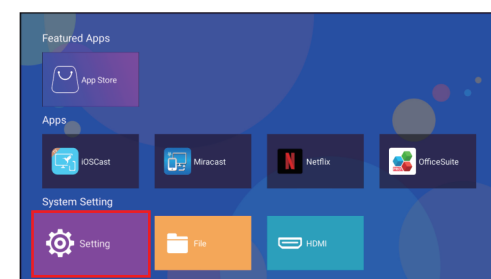

8 My Application

On the homepage, you have the option to choose applications for viewing content such as sports, games, music, and more. If you're not interested in certain applications, you can delete them by performing a long press of the button.

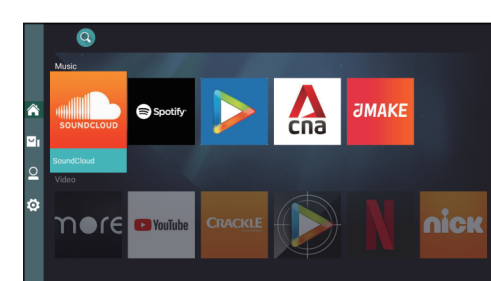
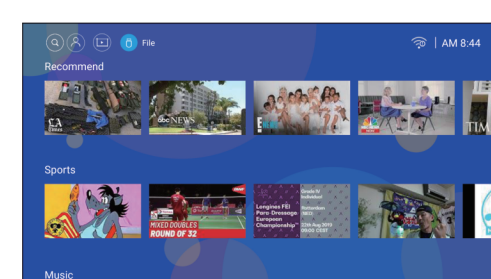

9 Activating Electronic Focus to Adjust Image Clarity

To activate the electronic focus feature, place the projector horizontally and simultaneously press both keys to adjust the image clarity.

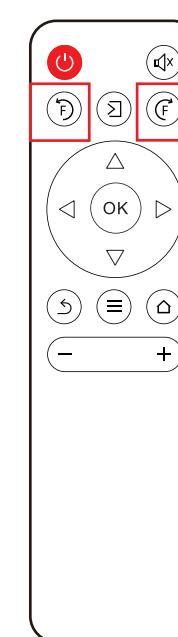

10 Product Specifications

Brightness (Lumens)	3600 Lumens
Imaging technology	TFT LCD
Resolution	1280*720
Maximum compatible resolution	1920*1080
Light	LED
Focus mode	Electronic focus
Projection distance	1.2-5.7 M
Screen size	40-200 inches
Aspect ratio	16:9
Power input	19V/3.42A
Input	USB*1/HDMI*1
Output	Earphone
Speaker	4Ω3W*2
Unit size	Ø118*179mm
Net weight	0.79KG
Projector ratio	1.38:1

Projector distance & size

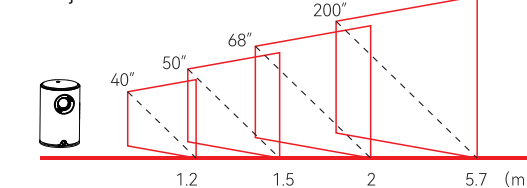

Note: Due to an optical error of 3%, the data above is for reference purposes only. Please use actual measurements when installing the device.



www.portronics.com

For Support

Visit : www.portronics.com

Email : help@portronics.com

Contact No. : +91 9555245245, 011-42413131

(Working Hrs. : Monday - Saturday, 10:00am - 6:00pm)



E-Waste Management
E: info@3rrecycler.com

For E-Waste & ROHS compliance
refer to www.portronics.com/ewaste



BEEM 410
Smart LED Projector